

Sales Code: VSQ1

Description: Exposed Sequential Thermo Valve

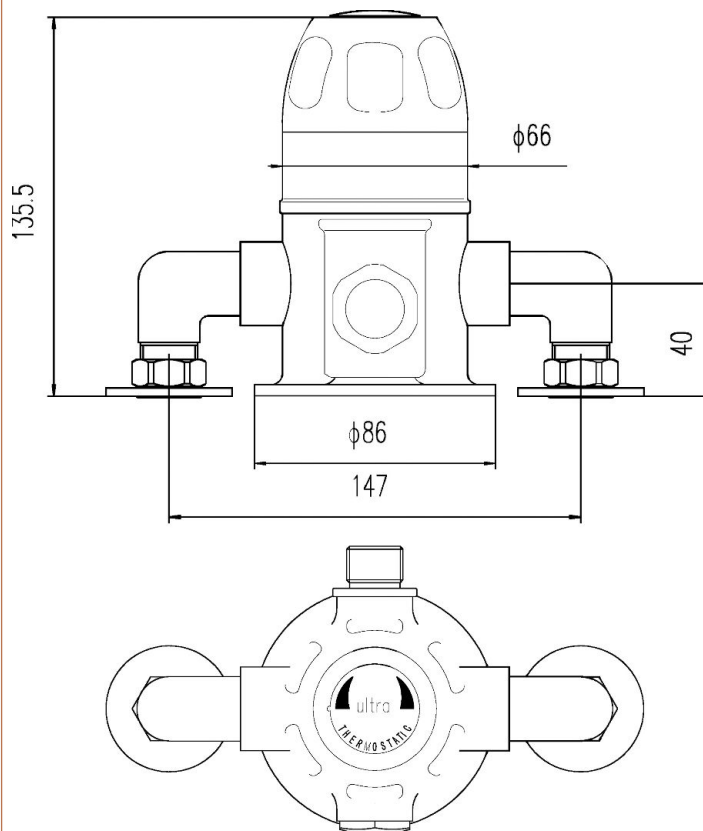

Product Dimensions

Length (mm):	
Width (mm):	205
Height (mm):	80
Depth (mm):	138
Nett Weight (kg):	2.7

Packaging Dimensions

Length (mm):	240
Width (mm):	210
Height (mm):	170
Gross Weight (kg):	2.7

Packaging Data

Box Colour:	White Cardboard Box
Box Qty:	1
Label Size:	100 x 50
Label Colour:	White Label
Label Qty:	1

Outer Box Dimensions (If Applicable)

Length (mm):	
Width (mm):	500
Height (mm):	365
Depth (mm):	445
Gross Weight (kg):	
Barcode:	5055275826713

Product Details

Country of Origin:	United Kingdom
Fitting Instruction:	No
Product Material:	Brass
Mount Type:	Wall
Outlet Elbow Supplied:	Not Applicable
Easy Clean:	Not Applicable
Head Included:	No
Handset Included:	No
Body Jets Included:	Not Applicable
No of Body Jets:	Not Applicable
Operating Pressure (bar):	0.2
Valve/Cartridge Type:	Sequential Valve
Flow Rates (L/min):	0.1 bar: 4 0.5 bar: 9.5 1 bar: 15 2 bar: 22 3 bar: 27
TMV2 Approved:	No Approval No: N/A
TMV3 Approved:	No Approval No: N/A
WRAS Approved:	No Approval No: N/A
Head Function:	Not Applicable
Handset Function:	Not Applicable
Body Jet Info:	Not Applicable
Pipe Size:	15 mm (1/2" Bsp)
Pipe Centres:	147mm
Colour/Finish:	Chrome
Hose Included:	Not Applicable
No. of Outlets:	1